

温度保险丝

Thermal-Link (ATCO)

S系列 Series

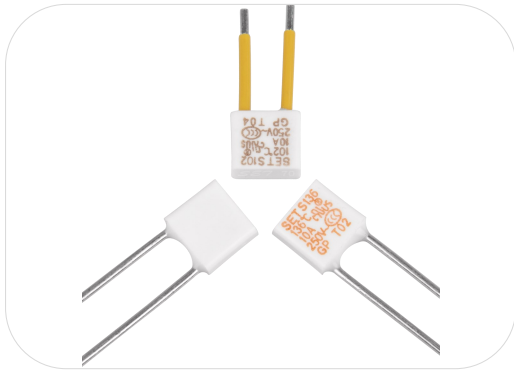

应用 Applications

- 灯具 Lamps
- 开关电源 Switched-Mode Power Supplies
- 家用电器 Home Electrical Appliances
- 防雷插座 Power Strips
- 电池 Batteries
- 电涌保护器 Surge Protective Devices

特性 Features

- 动作温度精确 High Accuracy of Functioning Temp.
- 一次性动作而不可复位 Non-Resettable
- 大通流容量 High Surge Capacity
- 环保型产品 RoHS & REACH Compliant

定制 Customization

- 温度 Temp.
- 引线长度 The Length of Lead Wires
- 可编带包装 Taping Packing Available
- 引线可采用绝缘线 Lead Wires Can Be Insulated

ATCO

ATCO

安规认证 Agency Approvals





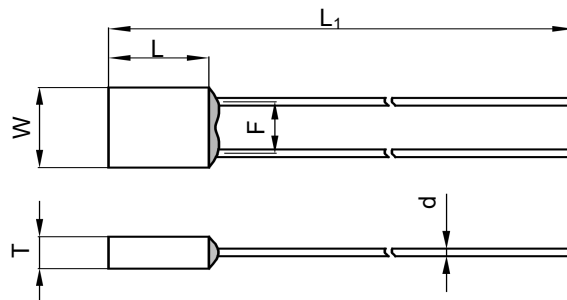

安规 Agency Mark	标准 Standards	认证号 No.
	UL 60691	E214712
	CAN-CSA-E60691	E214712
	EN 60691	40018082
	J60691	PSE16021061、PSE16021062
	GB 9816.1	2020980205000189

尺寸 Dimensions (mm)



L	L ₁	W	T	d	F
7.5 ± 0.5	35.0 ± 2.0	8.3 ± 0.5	3.4 ± 0.2	1.05 ± 0.05	5.2 ± 0.5

技术参数 Specifications

型号 Model	额定动作 温度 T_f	熔断 温度 Fusing Temp.	保持 温度 T_h	极限 温度 T_m	额定 电流 I_r	额定 电压 U_r	标称放电 电流 I_n 8 / 20 μ s (15 Times)	最大放电 电流 I_{max} 8 / 20 μ s (1 Time)							RoHS REACH
	(°C)	(°C)	(°C)	(°C)	(A)	(V)	(kA)	(kA)	UL	cUL	VDE	PSE	CCC	TUV	
S102	102	98 ± 2	72	200	10	AC 250	5	10	●	●	●	●	●	○	●
			61 ^a												
S115	115	111 ± 2	85	200	10	AC 250	5	10	●	●	●	●	●	○	●
			73 ^a												
S125	125	121 ± 2	95	200	10	AC 250	5	10	○	○	○	○	○	●	●
S136	136	131 ± 2	106	200	10	AC 250	5	10	●	●	●	●	●	○	●
			101 ^a												
S150	150	145 ± 2	118	200	10	AC 250	5	10	●	●	○	○	○	●	●

a: VDE标准升级要求，保持温度测温点明确为试验箱的环境温度；之前的测温点为产品本体。

a: VDE standard upgrade requirements, holding temperature(T_h) is defined as the inside environment temperature of test equipment cavity, the previous temperature measurement point is the product shell temperature.

备注 Note:

"●"表示产品已通过认证。Means certificated.

"○"表示产品未有认证。Means non-certificated.

温度保险丝

Thermal-Link (ATCO)

S系列 Series

产品温度时间曲线图 (仅供参考) Product Temp.-Time Curve (For Reference Only)

温度保险丝在不同温度油浴中断开的温度时间曲线。
The Temp.-Time Curve of Thermal-Link in different Temp. oil baths.

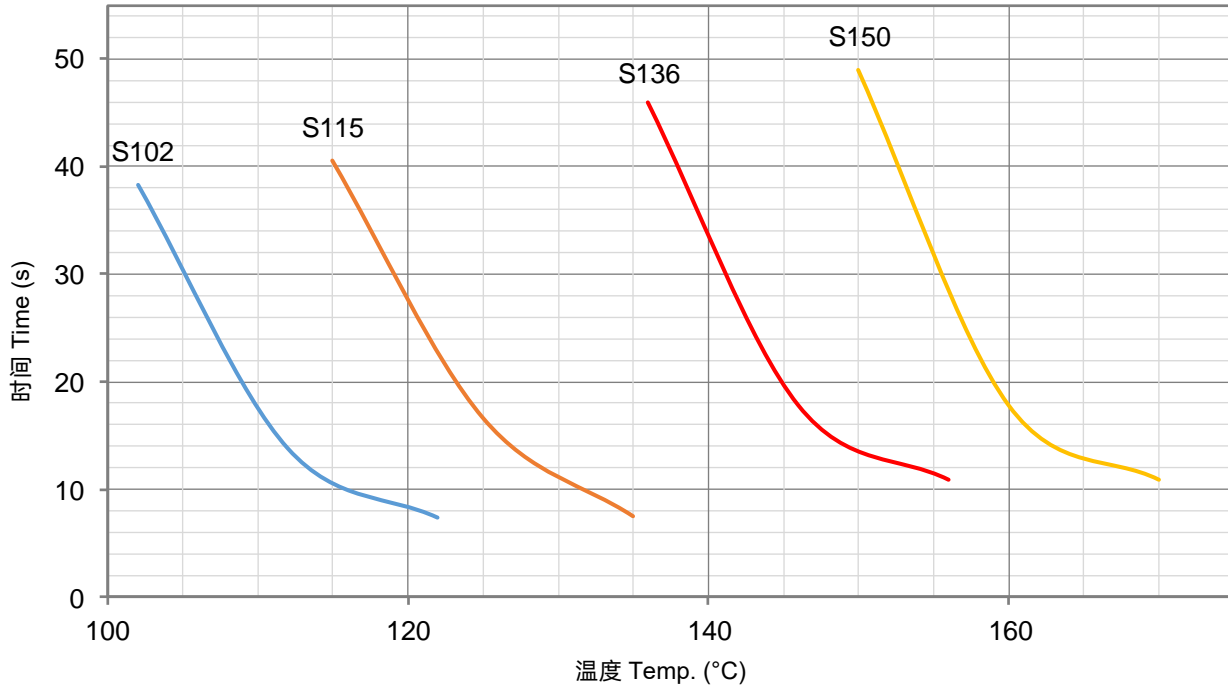

产品电流时间曲线图 (仅供参考) Product Current-Time Curve (For Reference Only)

温度保险丝在室温 25 ± 2 °C条件下, 测试数倍过载电流下的断开时间曲线。
The Current-Time Curve shows functioning time at multi-times rated current at room temperature 25 ± 2 °C.

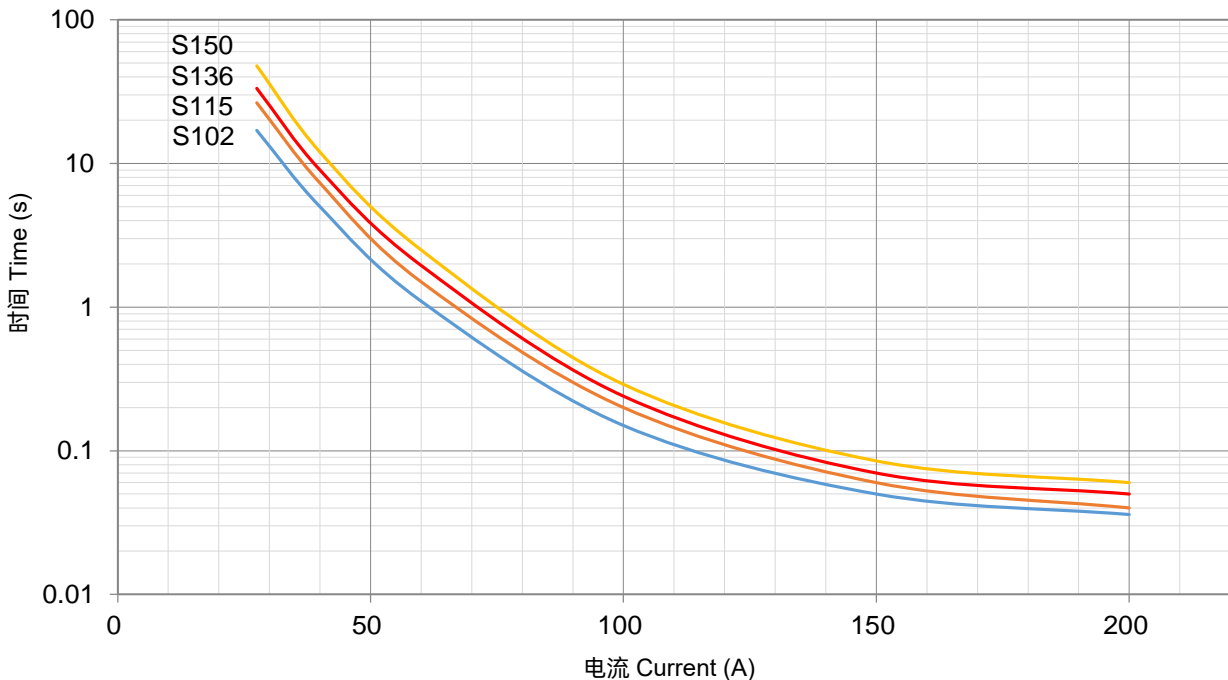

包装信息 Packaging Information

散装 Bulk

项目 Item	PE 袋 Bag	PE 袋 Bag	包装箱 Carton
尺寸 Dimensions (mm)	135 × 85	190 × 180	440 × 300 × 260
数量 Quantity (PCS)	50	500	20000
毛重 Gross Weight (kg)			17.0 ± 10%

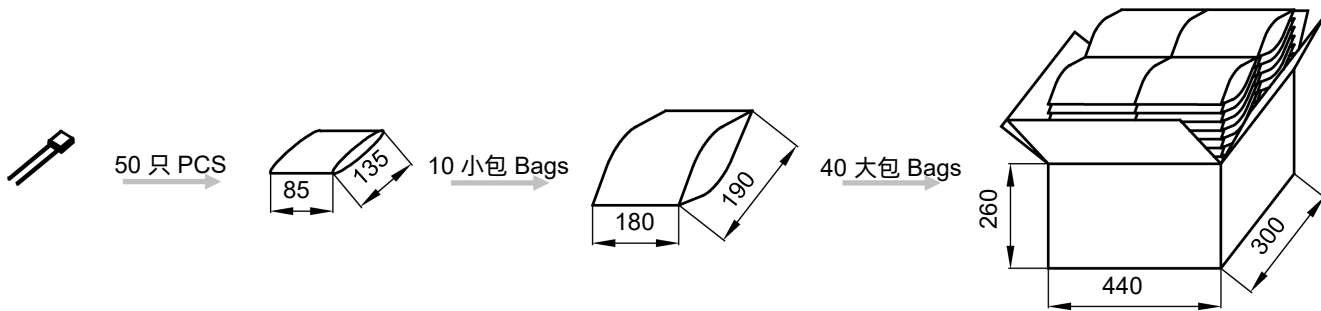

编带 Taping

项目 Item	盒子 Box	包装箱 Carton
尺寸 Dimensions (mm)	328 × 200 × 70	480 × 340 × 220
数量 Quantity (PCS)	2000	12000
毛重 Gross Weight (kg)		12.0 ± 10%

