

应用 Applications

- 灯具 Lamps
- 开关电源 Switched-Mode Power Supplies
- 家用电器 Home Electrical Appliances
- 电池 Batteries

特性 Features

- 动作温度精确 High Accuracy of Functioning Temp.
- 一次性动作而不可复位 Non-Resettable
- 预制安装孔 Make a Mounting Hole
- 环保型产品 RoHS & REACH Compliant

定制 Customization

- 温度 Temp.
- 引线长度 The Length of Lead Wires
- 可编带包装 Taping Packing Available
- 引线可采用绝缘线 Lead Wires can be Insulated
- 引线材质可选镀锡铜线或CP线 Tinned Copper Wires or CP Wires

安规认证 Agency Approvals



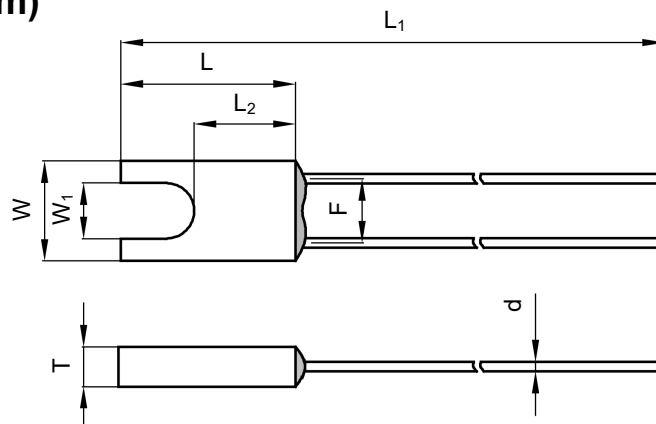

安规 Agency Mark	标准 Standards	认证号 No.
	UL 60691	E214712
	CAN-CSA-E60691	E214712
	EN 60691	R50384415
	J60691	PSE16021063、PSE16021064 PSE16021065、PSE16021066 PSE16021067、PSE16021068
	GB 9816.1	2020980205000195

尺寸 Dimensions (mm)



L	L ₁	L ₂	W	W ₁	T	d	F
10.0 ± 0.5	74.0 ± 3.0	5.8 ± 0.5	5.8 ± 0.5	3.2 ± 0.5	2.3 ± 0.2	0.54 ± 0.05	3.7 ± 0.5

技术参数 Specifications

型号 Model	额定动作 温度 T_f	熔断温度 Fusing Temp.	保持温度 T_h	极限温度 T_m	额定电流 I_r	额定电压 U_r						RoHS REACH
	(°C)	(°C)	(°C)	(°C)	(A)	(V)	UL	cUL	TUV	PSE	CCC	
XG0	76	73 ± 2	53	200	3	AC 250	●	●	●	●	●	●
XG18	86	81 ± 2	61	200	3	AC 250	●	●	●	●	●	●
						DC 60	●	●	○	○	○	○
XG1	102	98 ± 2	79	200	3	AC 250	●	●	●	●	●	●
						DC 60	●	●	○	○	○	○
XG2	115	111 ± 2	91	200	3	AC 250	●	●	●	●	●	●
						DC 60	●	●	○	○	○	○
XG3	125	121 ± 2	100	200	3	AC 250	●	●	●	●	●	●
						DC 60	●	●	○	○	○	○
XG4	130	125 ± 2	106	200	3	AC 250	●	●	●	●	●	●
XG8	133	130 ± 2	111	200	3	AC 250	●	●	●	●	●	●
XG5	135	130 ± 2	111	200	3	AC 250	●	●	●	●	●	●
XG9	136	131 ± 2	112	200	3	AC 250	●	●	●	●	●	●
XG6	145	140 ± 2	121	200	3	AC 250	●	●	●	●	●	●
XG7	150	145 ± 2	126	200	3	AC 250	●	●	●	●	●	●
XG16	160	154 ± 2	135	200	3	AC 250	○	○	●	●	●	●
XG32	205	199 ± 3	169	250	3	AC 250	●	●	●	●	○	●
XG31	221	218 ± 2	188	250	3	AC 250	●	●	●	●	○	●

备注 Note:

"●"表示产品已通过认证。Means certificated.

"○"表示产品未有认证。Means non-certificated.

ATCO

ATCO

产品温度时间曲线图 (仅供参考)
Product Temp.-Time Curve (For Reference Only)

温度保险丝在不同温度油浴中断开的温度时间曲线。
The Temp.-Time Curve of Thermal-Link in different Temp. oil baths.

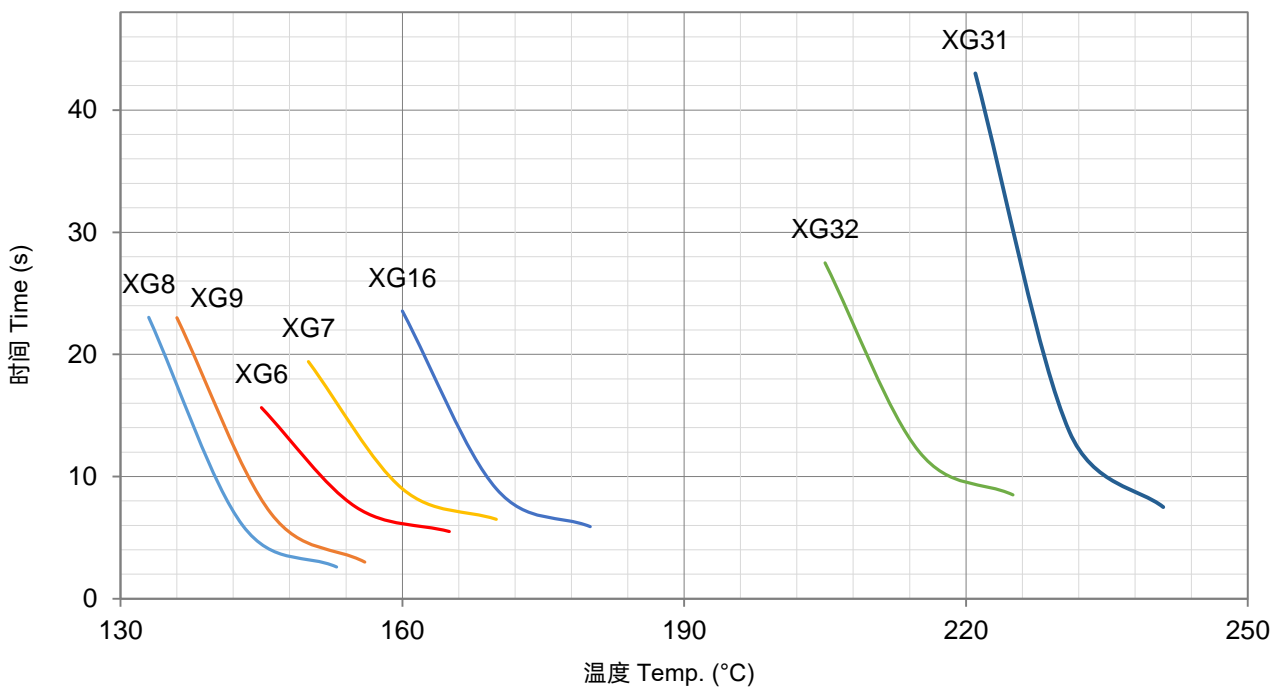
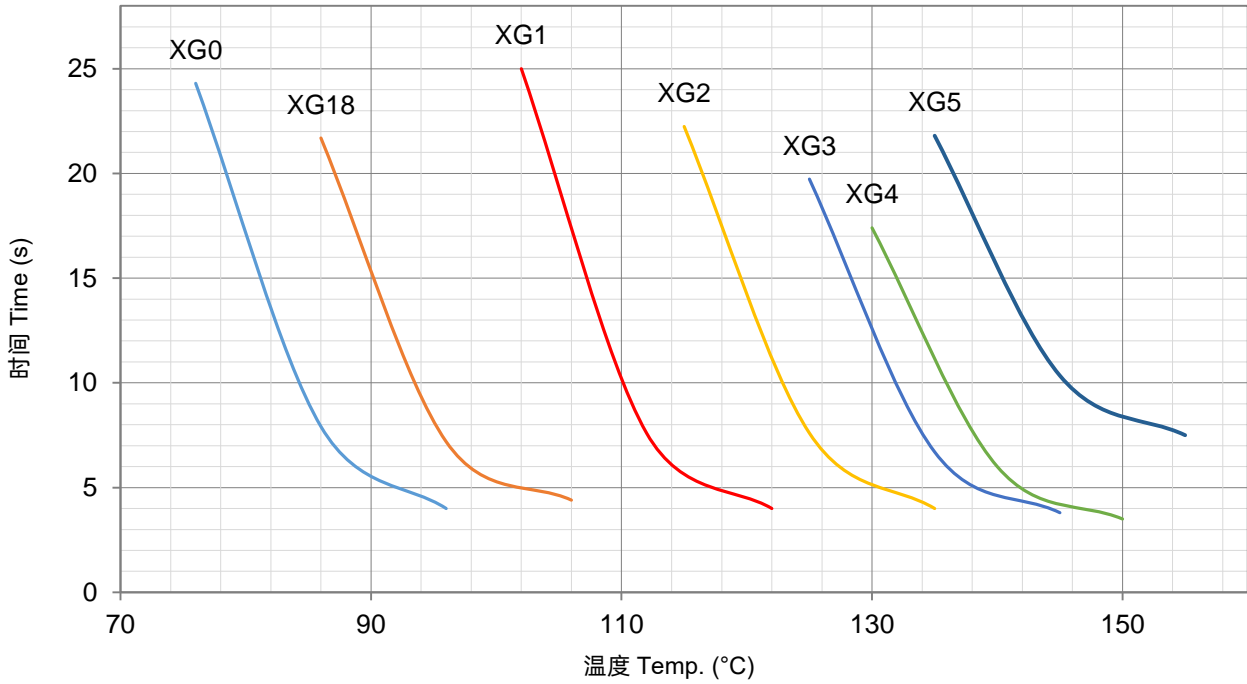

产品电流时间曲线图 (仅供参考)
Product Current-Time Curve (For Reference Only)

温度保险丝在室温 $25 \pm 2 \text{ }^\circ\text{C}$ 条件下, 测试数倍过载电流下的断开时间曲线。
The Current-Time Curve shows functioning time at multi-times rated current at room temperature $25 \pm 2 \text{ }^\circ\text{C}$.

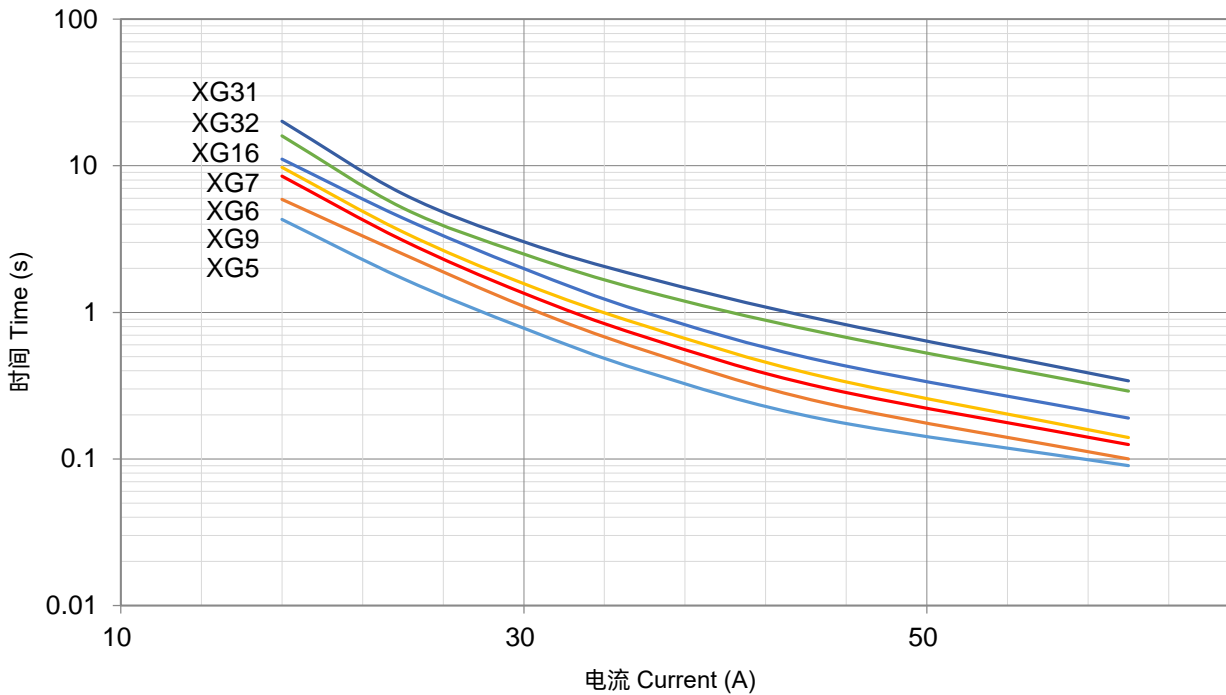
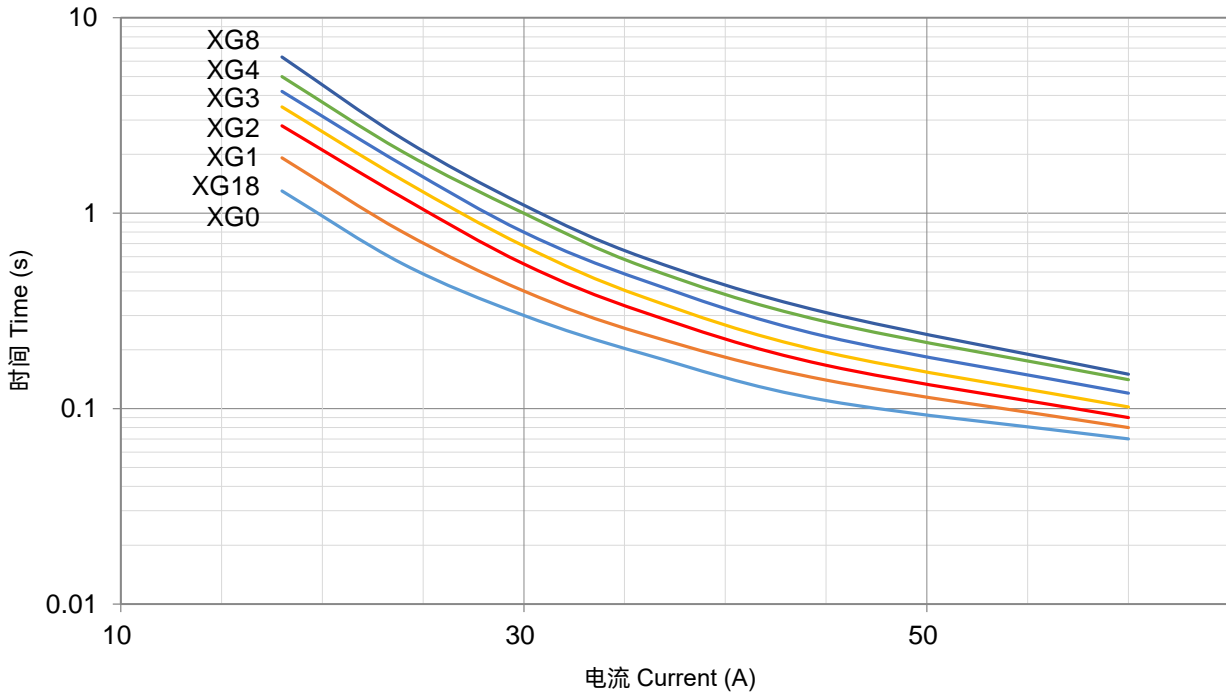

包装信息 Packaging Information

散装 Bulk

项目 Item	PE 袋 Bag	PE 袋 Bag	包装箱 Carton
尺寸 Dimensions (mm)	135 × 85	190 × 180	440 × 300 × 260
数量 Quantity (PCS)	100	1000	50000
毛重 Gross Weight (kg)			20.0 ± 10%

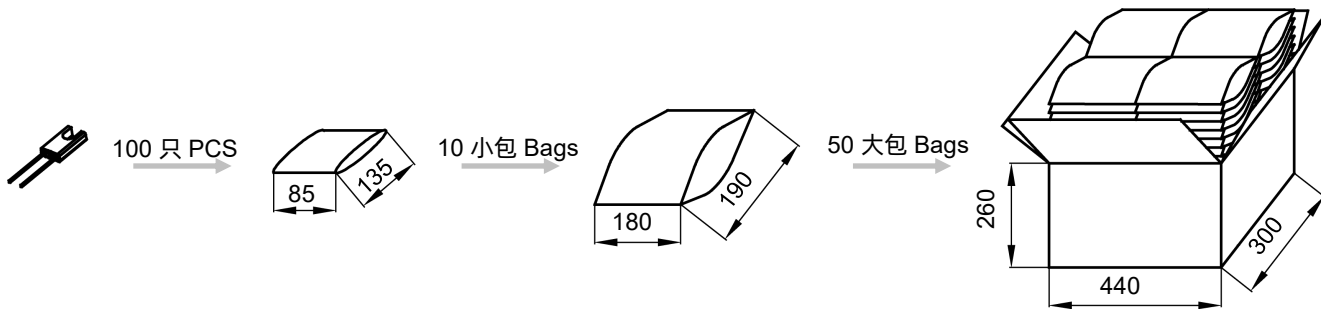

编带 Taping

项目 Item	盒子 Box	包装箱 Carton
尺寸 Dimensions (mm)	328 × 200 × 70	480 × 340 × 220
数量 Quantity (PCS)	2000	12000
毛重 Gross Weight (kg)	6.0 ± 10%	

