

# 温度保险丝

Thermal-Link (ATCO)

Y系列 Series

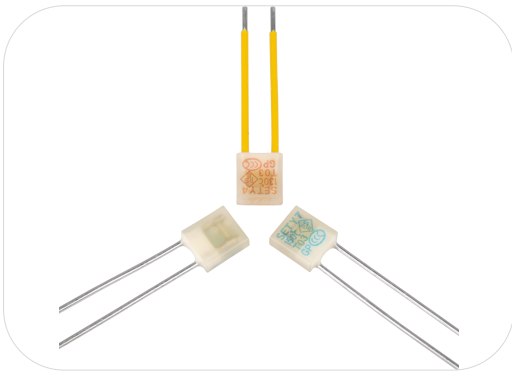

## 应用 Applications

- 灯具 Lamps
- 开关电源 Switched-Mode Power Supplies
- 家用电器 Home Electrical Appliances
- 防雷插座 Power Strips
- 电池 Batteries

## 特性 Features

- 动作温度精确 High Accuracy of Functioning Temp.
- 一次性动作而不可复位 Non-Resettable
- 环保型产品 RoHS & REACH Compliant

## 定制 Customization

- 温度 Temp.
- 引线长度 The Length of Lead Wires
- 可编带包装 Taping Packing Available
- 引线可采用绝缘线 Lead Wires can be Insulated
- 引线材质可选镀锡铜线或CP线 Tinned Copper Wires or CP Wires

## 安规认证 Agency Approvals

安规 Agency Mark	标准 Standards	认证号 No.
	UL 60691	E214712
	CAN-CSA-E60691	E214712
	EN 60691	R50408477、R50134734
	EN 60691	40017057
	J60691	PSE16021063、PSE16021064 PSE16021065、PSE16021066 PSE16021067、PSE16021068
	K60691	SU05023-6002A、SU05023-6003B
	GB 9816.1	2020980205000188

## 尺寸 Dimensions (mm)

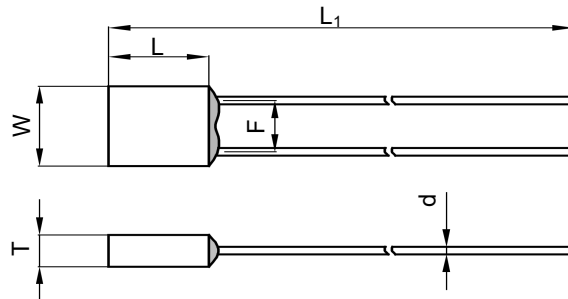







L	L <sub>1</sub>	W	T	d	F
7.0 ± 0.5	70.0 ± 3.0	6.6 ± 0.5	2.7 ± 0.2	0.80 ± 0.05	4.0 ± 0.5

ATCO

ATCO

技术参数 Specifications

型号 Model	额定动作 温度 $T_f$	熔断温度 Fusing Temp.	保持 温度 $T_h$	极限 温度 $T_m$	额定 电流 $I_r$	额定电压 $U_r$	标称放电 电流 $I_n$ 8 / 20 $\mu$ s (15 Times)	最大放电 电流 $I_{max}$ 8 / 20 $\mu$ s (1 Time)								RoHS REACH
	(°C)	(°C)	(°C)	(°C)	(A)	(V)	(kA)	(kA)	UL	cUL	TUV	VDE	PSE	KTL	CCC	
Y0	76	73 ± 2	53	200	5	AC 250	2	4	●	●	●	○	●	○	●	●
Y18	86	81 ± 2	61	200	5	AC 250	2	4	●	●	●	○	●	○	●	●
Y1	102	98 ± 2	77	200	5	AC 250	2	4	●	●	●	○	●	●	●	●
Y2	115	111 ± 2	89	200	5	AC 250	3	6	●	●	○	●	●	●	●	●
Y3	125	121 ± 2	98	200	5	AC 250	3	6	●	●	○	●	●	●	●	●
Y4	130	125 ± 2	103	200	5	AC 250	3	6	●	●	●	●	●	●	●	●
						AC 300	3	6	●	●	●	○	○	○	○	●
Y8	133	130 ± 2	108	200	5	AC 250	3	6	●	●	○	●	●	●	●	●
Y9	136	131 ± 2	111	200	5	AC 250	3	6	●	●	●	●	●	●	●	●
						AC 300	3	6	●	●	●	○	○	○	○	●
Y6	145	140 ± 2	118	200	5	AC 250	3	6	●	●	○	○	●	○	○	●
Y7	150	145 ± 2	123	200	5	AC 250	3	6	●	●	●	●	●	●	●	●
						AC 300	3	6	●	●	●	○	○	○	○	●
Y16	160	154 ± 2	133	200	5	AC 250	3.5	7	○	○	○	○	●	○	●	●
Y17	187	182 ± 3	160	200	5	AC 250	3.5	7	○	○	●	○	○	○	○	●

备注 Note:

"●"表示产品已通过认证。Means certificated.

"○"表示产品未有认证。Means non-certificated.

ATCO

ATCO

产品温度时间曲线图 (仅供参考)

Product Temp.-Time Curve (For Reference Only)

温度保险丝在不同温度油浴中断开的温度时间曲线。  
The Temp.-Time Curve of Thermal-Link in different Temp. oil baths.

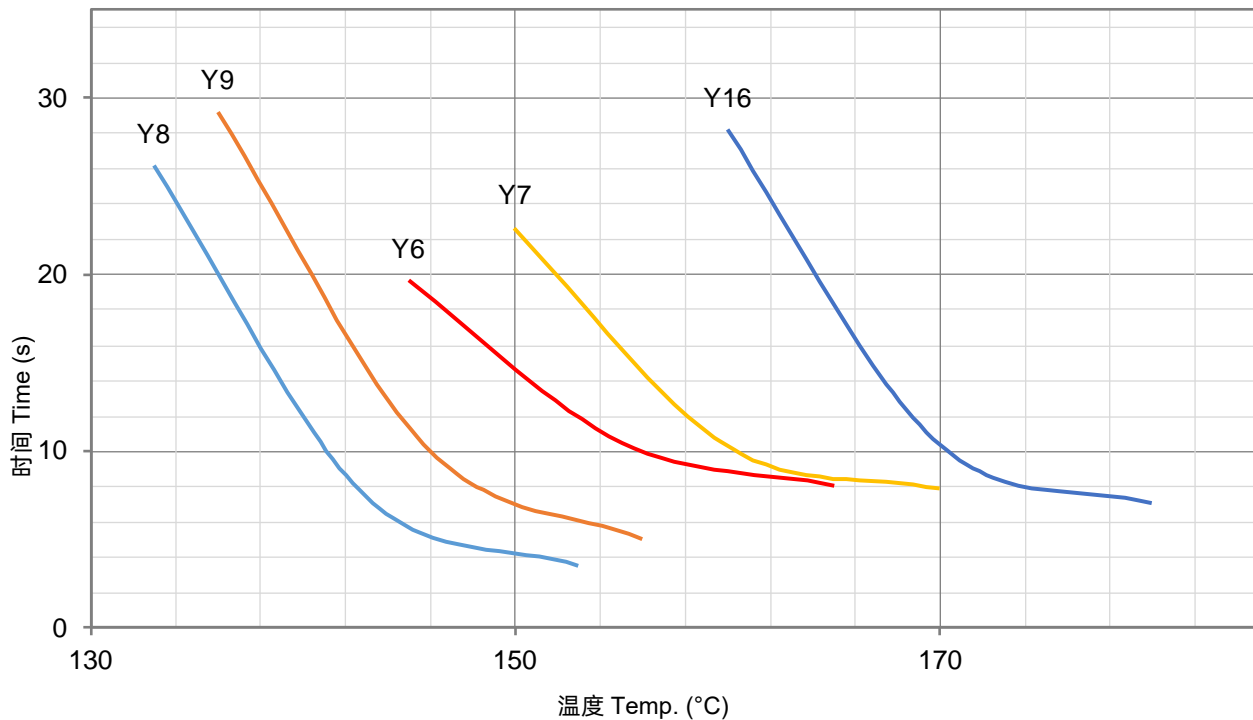
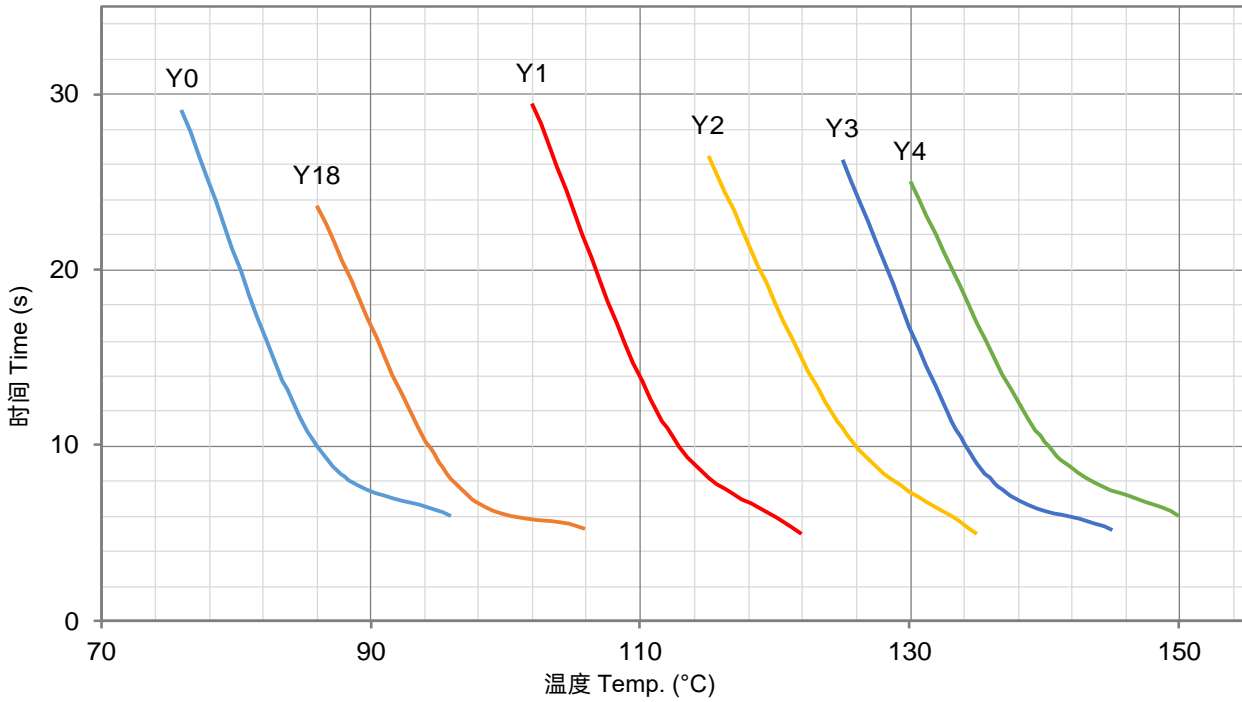

产品电流时间曲线图 (仅供参考)  
Product Current-Time Curve (For Reference Only)

温度保险丝在室温 $25 \pm 2 \text{ }^\circ\text{C}$ 条件下, 测试数倍过载电流下的断开时间曲线。  
The Current-Time Curve shows functioning time at multi-times rated current at room temperature  $25 \pm 2 \text{ }^\circ\text{C}$ .

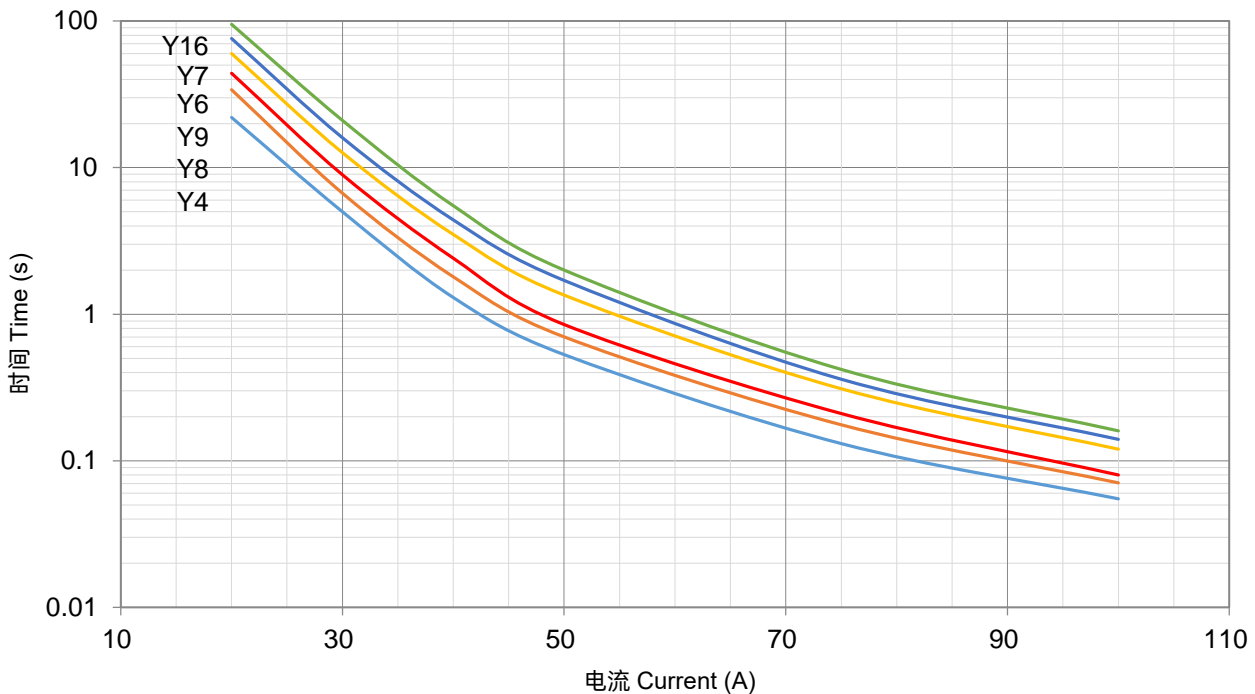
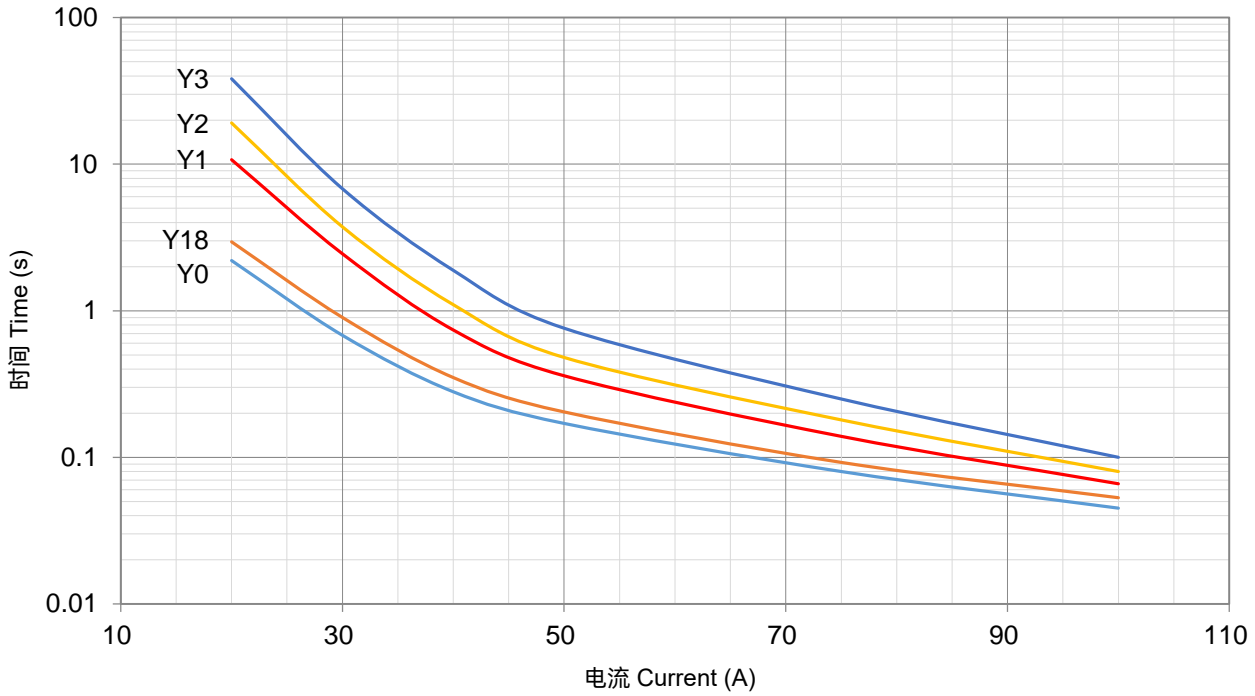

包装信息 Packaging Information

散装 Bulk

项目 Item	PE 袋 Bag	PE 袋 Bag	包装箱 Carton
尺寸 Dimensions (mm)	135 × 85	190 × 180	440 × 300 × 260
数量 Quantity (PCS)	100	1000	25000
毛重 Gross Weight (kg)			17.0 ± 10%

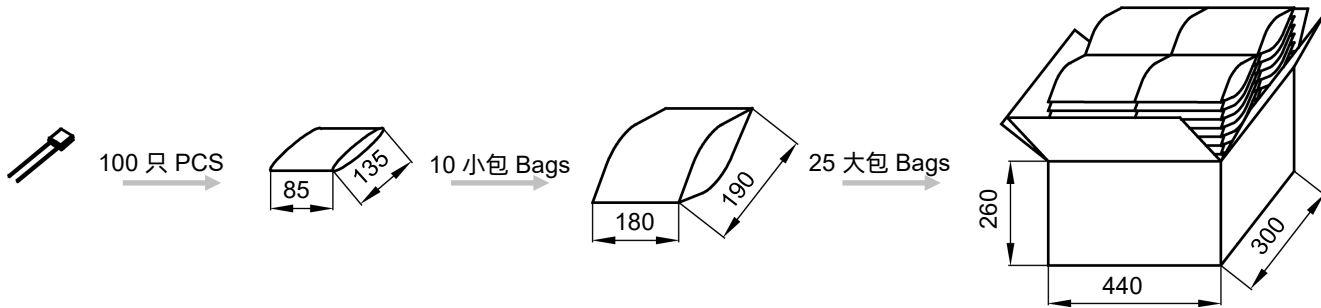

编带 Taping

项目 Item	盒子 Box	包装箱 Carton
尺寸 Dimensions (mm)	328 × 200 × 70	480 × 340 × 220
数量 Quantity (PCS)	2000	12000
毛重 Gross Weight (kg)		9.0 ± 10%

