

温度保险丝

Thermal-Link (ATCO)

YM系列 Series

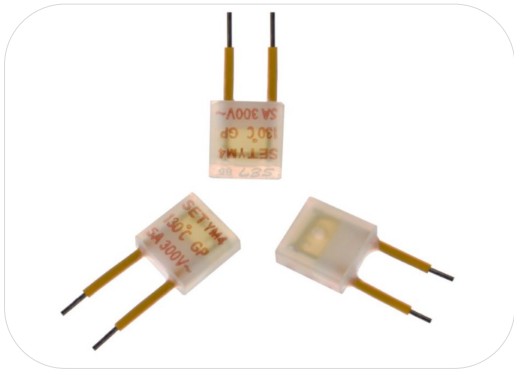

应用 Applications

- 灯具 Lamps
- 开关电源 Switched-Mode Power Supplies
- 家用电器 Home Electrical Appliances
- 防雷插座 Power Strips
- 电池 Batteries



特性 Features

- 动作温度精确 High Accuracy of Functioning Temp.
- 一次性动作而不可复位 Non-Resettable
- 额定电压 Rated Voltage 300 VAC
- 环保型产品 RoHS & REACH Compliant

定制 Customization

- 温度 Temp.
- 引线长度 The Length of Lead Wires
- 可编带包装 Taping Packing Available
- 引线可采用绝缘线 Lead Wires can be Insulated
- 引线材质可选镀锡铜线或CP线 Tinned Copper Wires or CP Wires

安规认证 Agency Approvals

安规 Agency Mark	标准 Standards	认证号 No.
	UL 60691	E214712
	CAN-CSA-E60691	E214712
	EN 60691	R50408477

尺寸 Dimensions (mm)

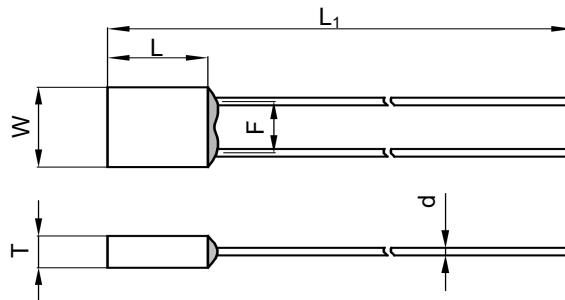

L	L ₁	W	T	d	F
7.0 ± 0.5	50.0 ± 2.0	6.6 ± 0.5	2.7 ± 0.2	0.80 ± 0.05	4.0 ± 0.5

技术参数 Specifications

型号 Model	额定动作 温度 T_f	熔断温度 Fusing Temp.	保持温度 T_h	极限温度 T_m	额定电流 I_r	额定电压 U_r	标称放电 电流 I_n 8 / 20 μ s (15 Times)	最大放电电 流 I_{max} 8 / 20 μ s (1 Time)				RoHS REACH
	(°C)	(°C)	(°C)	(°C)	(A)	(V)	(kA)	(kA)	UL	cUL	TUV	
YM4	130	125 ± 2	103	200	5	AC 300	3	6	●	●	●	●
YM9	136	131 ± 2	111	200	5	AC 300	3	6	●	●	●	●
YM7	150	145 ± 2	123	200	5	AC 300	3	6	●	●	●	●

备注 Note:

"●"表示产品已通过认证。Means certificated.

"○"表示产品未有认证。Means non-certificated.

ATCO

ATCO

产品温度时间曲线图 (仅供参考)

Product Temp.-Time Curve (For Reference Only)

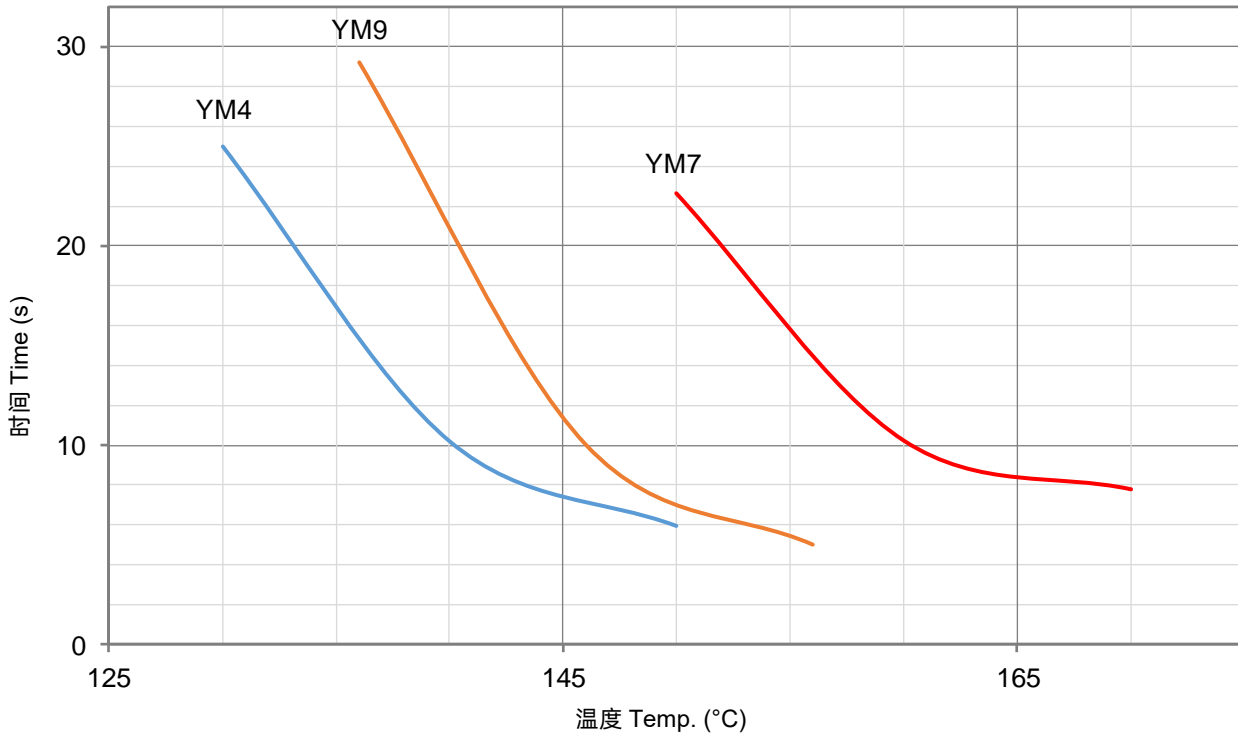

产品电流时间曲线图 (仅供参考)

Product Current-Time Curve (For Reference Only)

温度保险丝在室温 $25 \pm 2^\circ\text{C}$ 条件下, 测试数倍过载电流下的断开时间曲线。

The Current-Time Curve shows functioning time at multi-times rated current at room temperature $25 \pm 2^\circ\text{C}$.

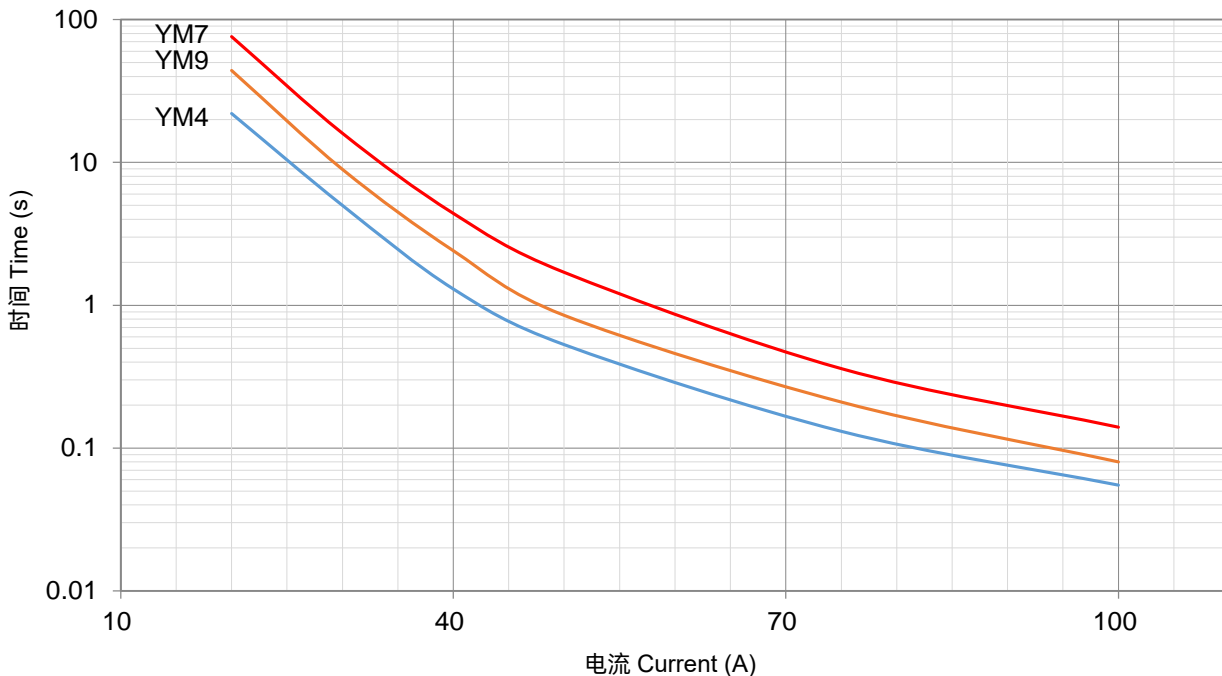

包装信息 Packaging Information

散装 Bulk

项目 Item	PE 袋 Bag	PE 袋 Bag	包装箱 Carton
尺寸 Dimensions (mm)	135 × 85	190 × 180	440 × 300 × 260
数量 Quantity (PCS)	100	1000	25000
毛重 Gross Weight (kg)			15.0 ± 10%

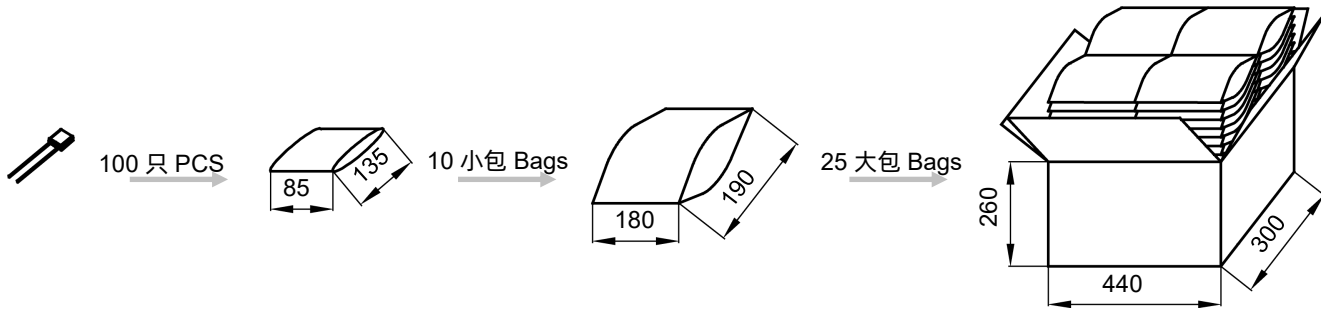

编带 Taping

项目 Item	盒子 Box	包装箱 Carton
尺寸 Dimensions (mm)	328 × 200 × 70	480 × 340 × 220
数量 Quantity (PCS)	2000	12000
毛重 Gross Weight (kg)		8.0 ± 10%

